

29428 E

Dimensions

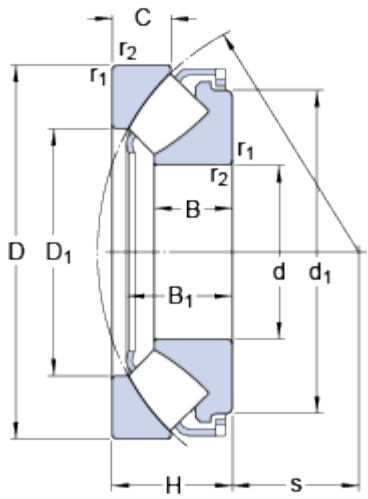

d	140	mm
D	280	mm
H	85	mm
d ₁	≈ 245	mm
D ₁	≈ 195	mm
B	54	mm
B ₁	75.6	mm
C	41	mm
s	86	mm
r _{1,2}	min. 4	mm

Abutment dimensions

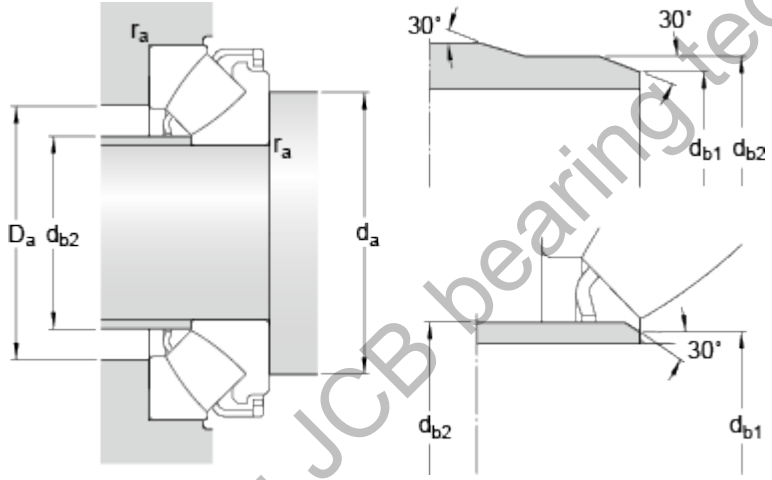

d _a	min. 205	mm
d _{b1}	max. 153	mm
d _{b2}	max. 162	mm
D _a	max. 236	mm
r _a	max. 3	mm

Calculation data

Basic dynamic load rating	C	1630	kN
Basic static load rating	C ₀	4300	kN
Fatigue load limit	P _u	455	kN
Reference speed		1300	r/min
Limiting speed		2400	r/min
Minimum axial load factor	A	1.8	

Mass

Mass bearing		23	kg
--------------	--	----	----